

37722 Schiebeplanenwagen Shimmns

Tarpaulin Car · Wagon bâché à bogies

Staalrollenwagen Shimmns

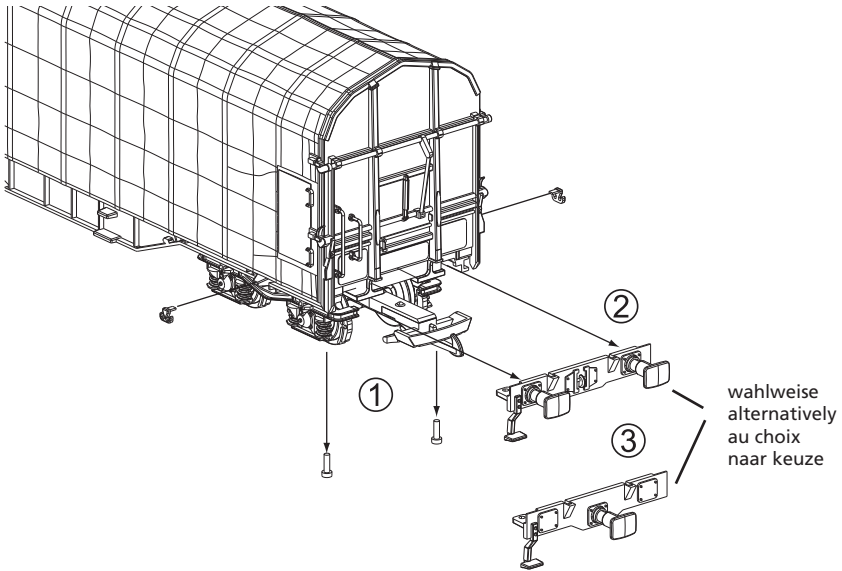

37722-90-7000

ERSATZTEILE

Spare parts · Pièces détachées · Reserveonderdelen

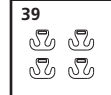
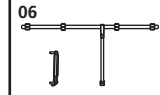
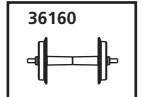
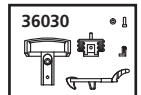
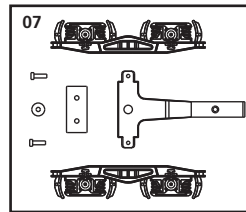
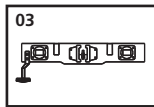
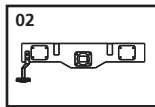
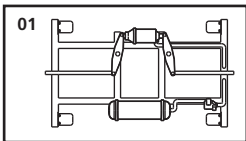

Nr:	Bezeichnung:	Description:	Désignation:	Beschrijving:	PG*
37700-01	Bremsgestänge	Brake rods	Conduites de freins	Remsysteem	8
37700-02	Pufferbohle für Mittelpuffer	End Beam for central buffer	Traverse de tamponnement (tampon central)	Bufferbalk (middenbuffer)	8
37700-03	Pufferbohle für 2 Puffer	End Beam for 2 buffers	Traverse de tamponnement (2 tampons)	Bufferbalk (2 buffers)	8
37700-04	Puffer (2 St.)	Buffers (set of 2)	Tampons (2 unités)	Buffer (2 stuks)	6
37701-05	Handstangen	Handrails	Poignées	Handgrepen	8
37722-06	Hydraulikgestänge	Hydraulic rodding	Conduites hydrauliques	Hydraulische bediening	8
37700-07	Drehgestell	Bogie	Bogie	Draaistel	12
37700-39	Seilanker (4 St.)	Anchor (set of 4)	Ancre (4 pièces)	Anker (4 stuks)	8
36030	Standard Ersatzteile Kupplung komplett	Spare parts, standard range Standard Coupler	Pièces détachées standard Attelage, complet	Standaardonderdelen Koppeling, volledig	
36090	Schrauben-Set (20-tlg./5 Größen)	Set of screws (20 pieces / 5 sizes)	Jeu de vis (20 pièces, 5 tailles)	Set schroeven (20-delig)	
36160	Radsatz Kunststoff 2 St.)	Plastic wheel set (set of 2)	Essieux plastiques (2 unités)	Kunststof wielstel (2-delig)	
36164	Radsatz Metall (2 St.)	Metal wheel set (set of 2)	Essieux métalliques (2 unités)	Metalen wielstel (2-delig)	